

8+

# TRANSFORMERS LEGACY EVOLUTION

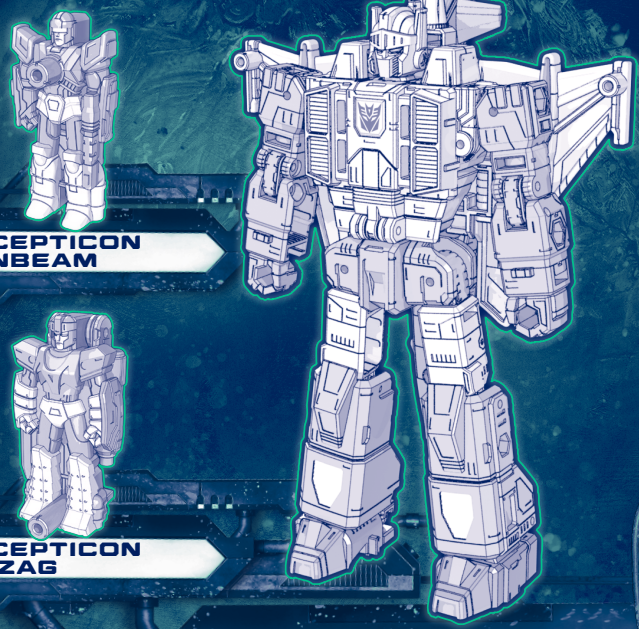

# TRANSFORMERS



DECEPTICON  
SUNBEAM



DECEPTICON  
ZIGZAG



NEEDLENOSE

Manufactured under license from TOMY Company, Ltd. TRANSFORMERS and HASBRO and all related trademarks and logos are trademarks of Hasbro, Inc. © 2023 Hasbro. Hasbro, Pawtucket, RI 02861-1059 USA. HASBRO CANADA, LONGUEUIL, QC, CANADA J4G 1G2. US/CANADA TEL. 1-800-255-5516. Importado por: HASBRO DE MEXICO, S. DE R.L. DE C.V. Boulevard Manuel Avila Camacho #32, piso 3, Colonia Lomas de Chapultepec | Sección, Alcaldía Miguel Hidalgo, C.P. 11000, Ciudad de México, México. Centro de Servicio para México: TEL. 5876-2998 y para el interior de la República TEL. 01-800-7-12-62-25. Manufactured by/Produs de: Hasbro SA, Rue Emile-Boéchat 31, 2800 Delémont, CH. Represented by/Reprezentat de: Hasbro, De Entree 240, 1101 EE Amsterdam, NL. GB Hasbro UK Ltd., P.O. Box 43, Newport, NP19 4YH, UK. TR Üretici Firma Bilgileri: Hasbro SA, Rue Emile-Boéchat 31, 2800 Delémont İsviçre TEL +41 324210800. Hasbro Oyuncak San. ve Tic. A.Ş. tarafından ithal edilmiştir. Tüketici Hizmetleri: Burhaniye Mah. Abdullahağa Cad. No: 51/2 34676 Beylerbeyi İstanbul Türkiye TEL +90 2164229010.

F7188/F2990 Asst. PNO0077883

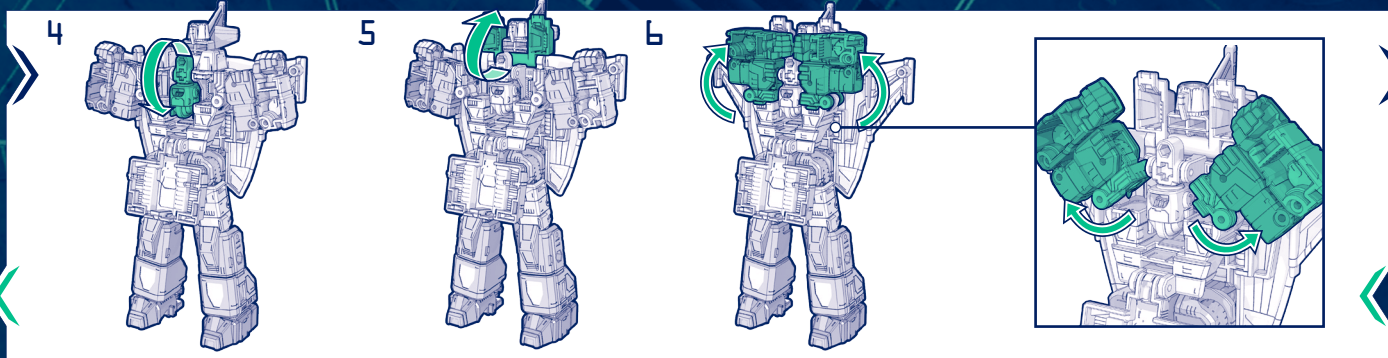
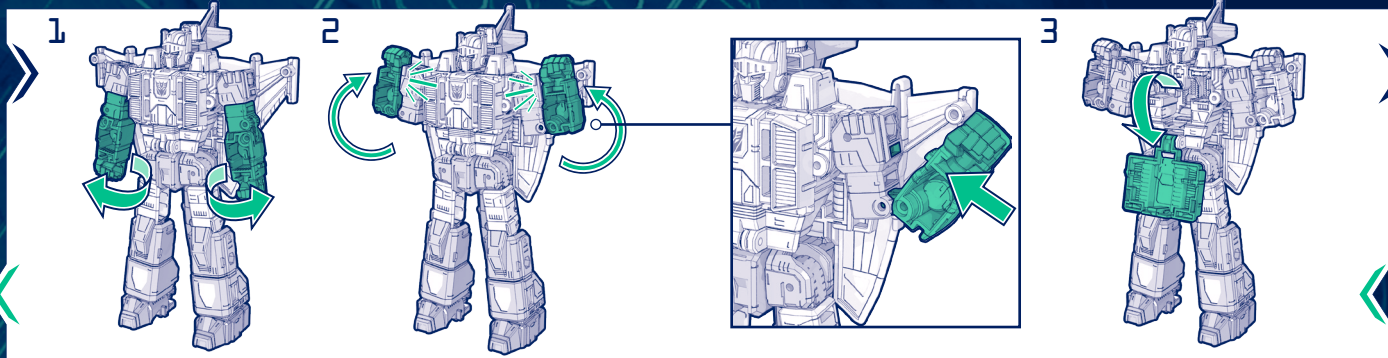
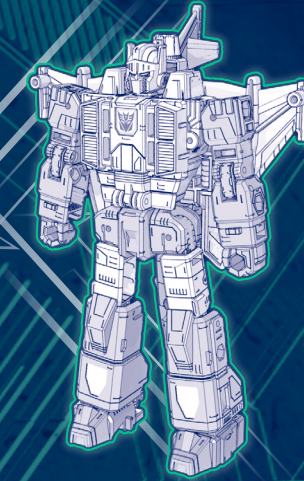
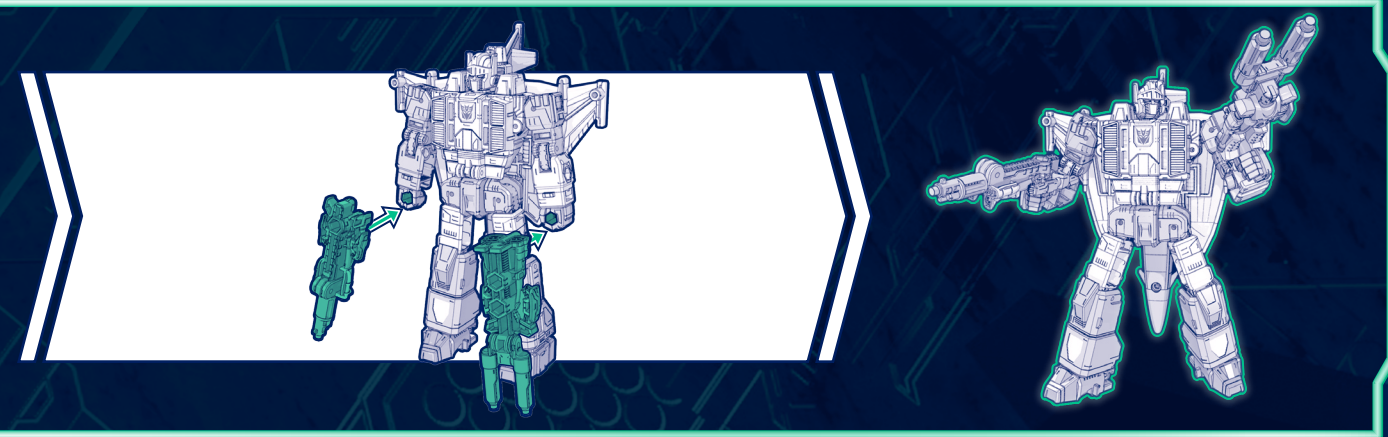
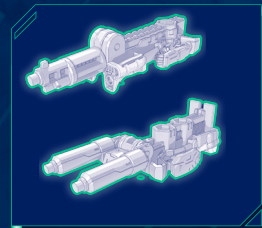
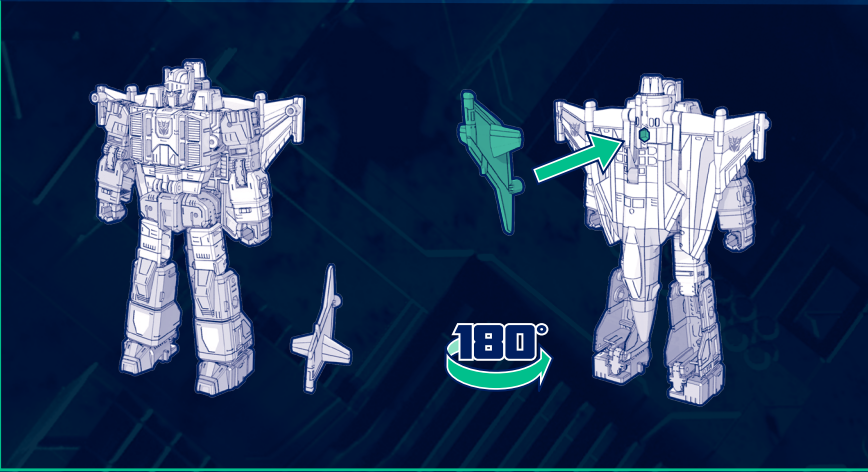

CREATIVE DEVELOPMENT STUDIOS // CREATIVE COMMUNICATIONS

NAME	Sarah Jean Rovenko	FLAT SIZE	20" x 6.5"	FOLDS	3	SINGLE or DOUBLE SIDED	Double
EMAIL	Sarah.Rovenko@hasbro.com	PDP SIZE	5" x 6.5"	COLORS	PMS 2758, 3395		

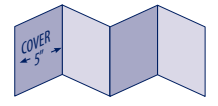



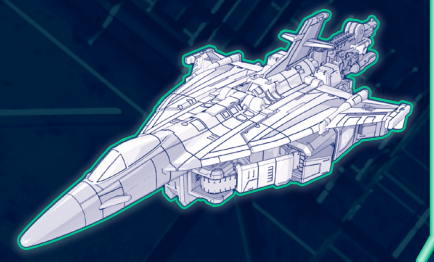
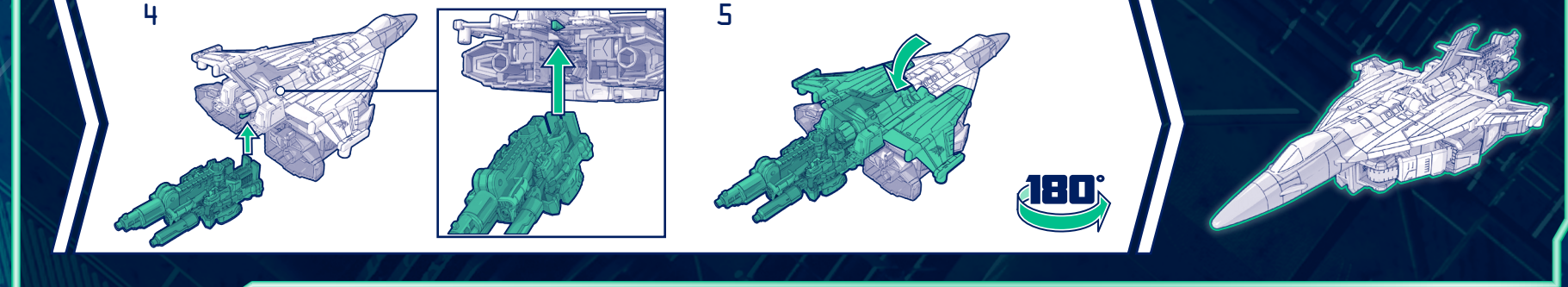
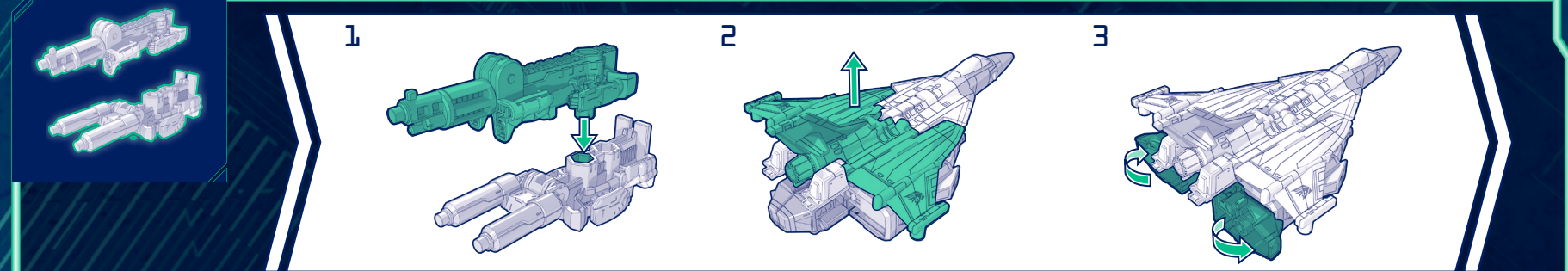
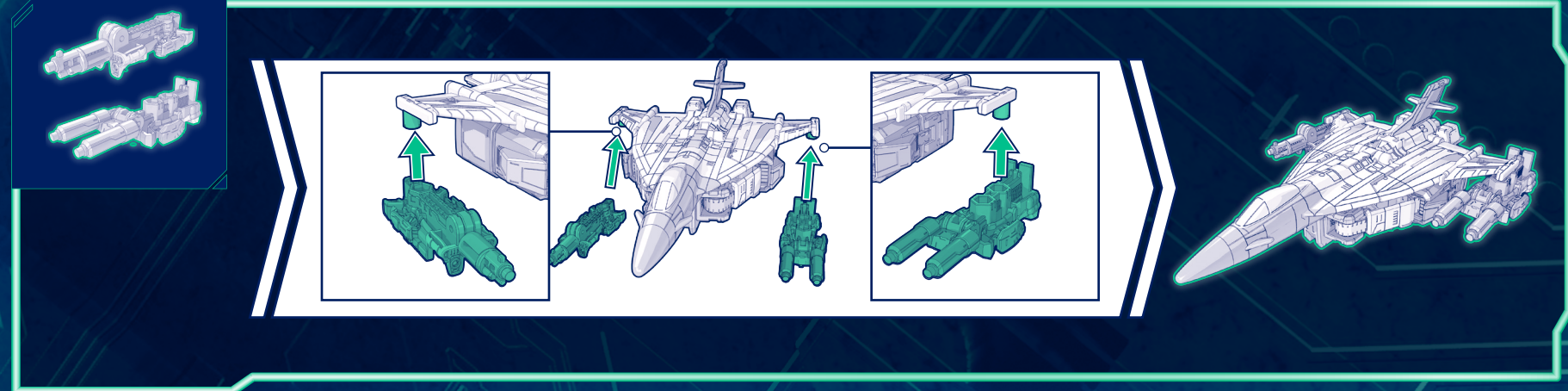
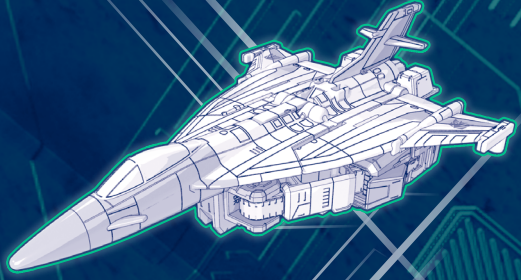
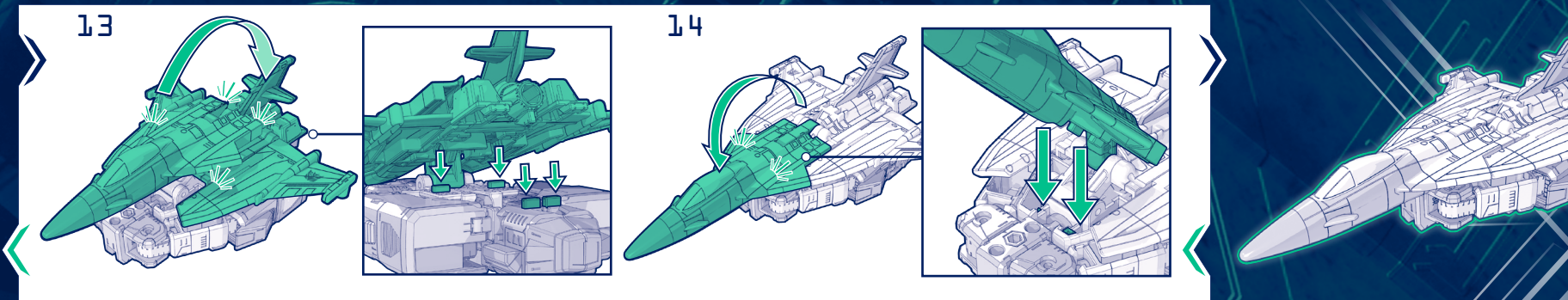
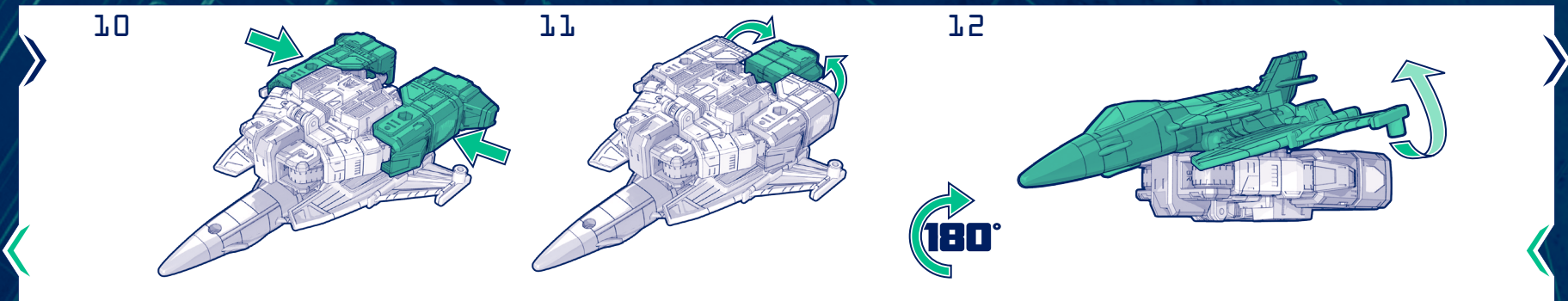
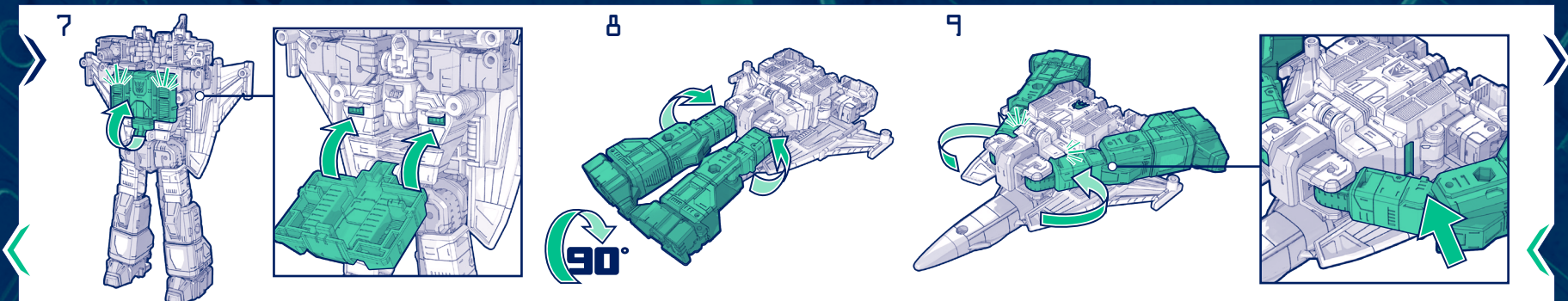

(en) Retain instructions for future reference. (fr) Conservez ces instructions pour référence ultérieure. (de) Bitte die Anleitung für spätere Rückfragen aufbewahren. (es) Conserve este instructivo para futuras referencias. (pt) Guardar instruções para eventuais consultas. (it) Conserva le istruzioni come futuro riferimento. (nl) Bewaar de gebruiksaanwijzing om later nog eens te lezen.  
 (sv) Spara instruktionerna för att kunna hänvisa till dem i framtiden. (da) Gem vejledningerne til fremtidig referencebrug. (no) Ta vare på disse instruksjonene for fremtidig referanse. (fi) Säilytä nämä tiedot tulevaa tarvetta varten. (ru) Сохраните инструкции по дальнейшему использованию. (pl) Zachowaj instrukcje na przyszłość. (hu) Őrizd meg a használati útmutatót. (tr) Heride basyurmak üzere talimatları saklayın. (uk) Ця інформація усюди вказує на подальші кроки. (it) Návod si odložte na použitie v budúcnosti. (ro) Păstrați instrucțiunile pentru a le consulta în viitor. (bg) Сохранете инструкциите за бъдещи справки. (hr) Sačuvajte upute za buduću upotrebu. (lv) Instrukcija pasliktie ateižai. (sl) Navodila shranite, mogoče jih boš še potreboval. (ukr) Збережіть інструкції для подальшого використання. (et) Jäta juhised edasiseks kasutamiseks alles. (is) Saglabajett instruksjónu atsauei. (ar) احتفظ بالتعليمات للرجوع اليها في المستقبل.